

# ROSTA Rubber Suspension Units

**Multifunctional Modules for the Machine Industries**  
guiding – tensioning – absorbing



# ROSTA Rubber torsion-elastic spring assemblies for



pendulum suspensions for unbalanced motors  
torque supports for gear motors

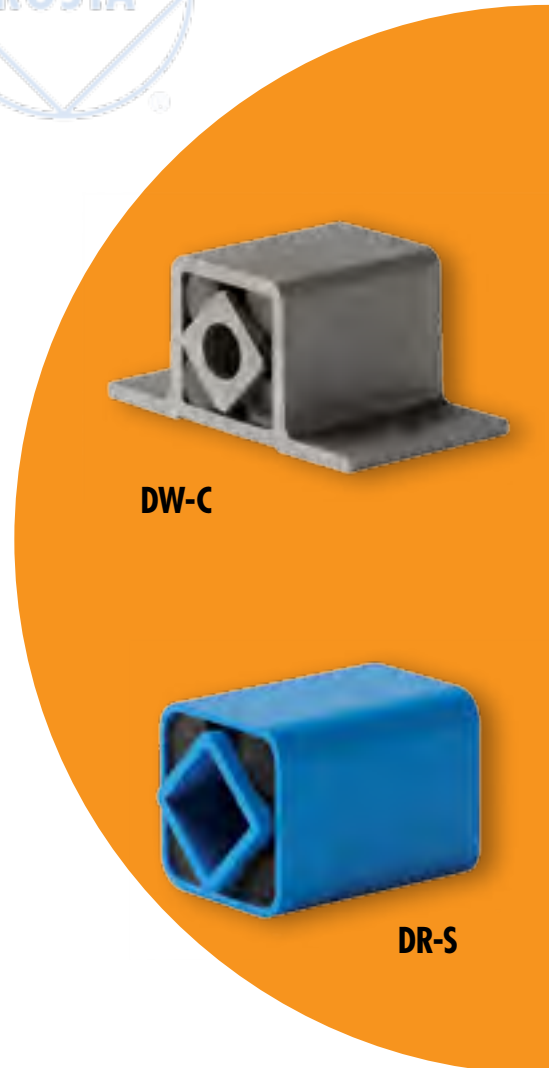
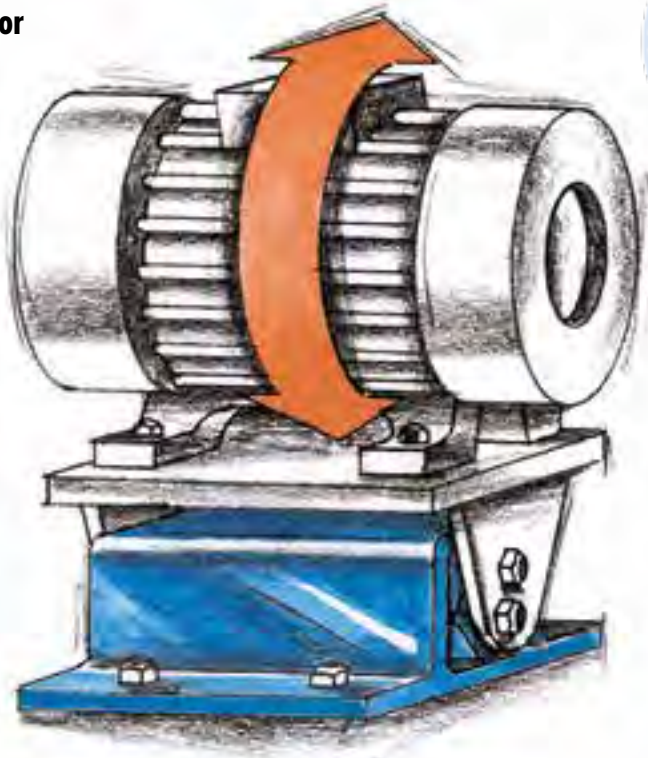

DW-C

DR-S

torsional springs for continuous surface pressure

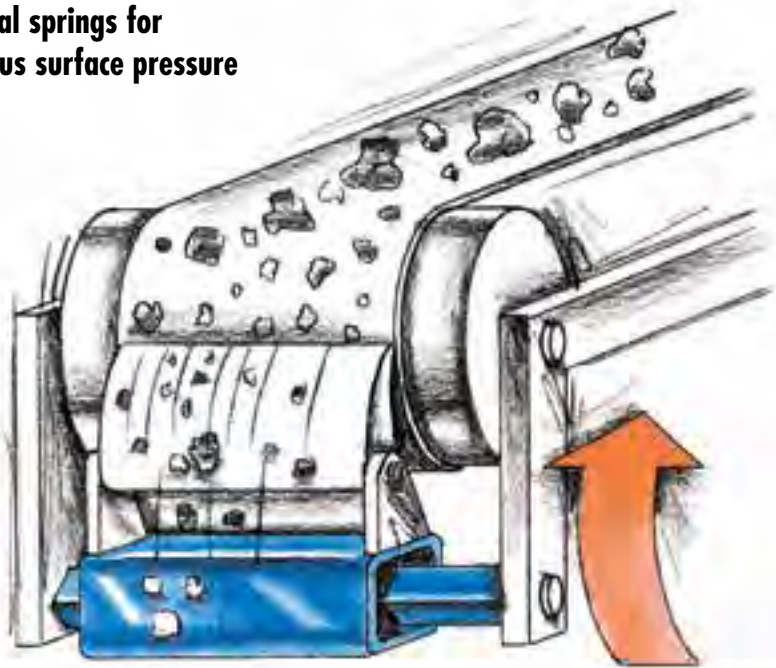

fully customized rubber suspensions in exclusive design according specific request



# Suspension Units

## the contemporary machine engineering

torsion elastic mounts offering constant pressure on workparts (infeed devices)

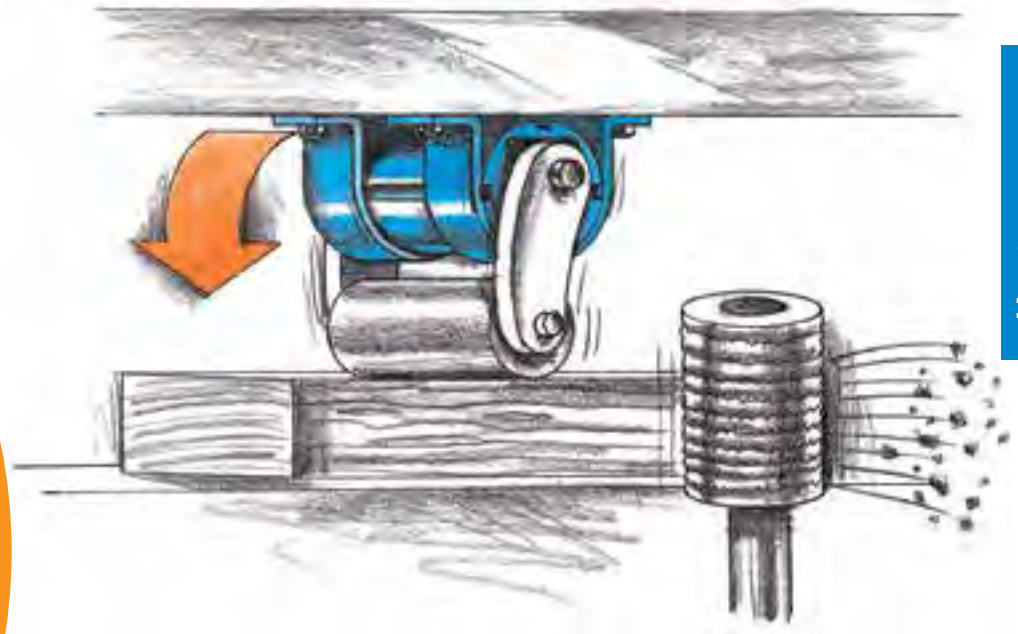

Rubber Suspension Units



DK-A







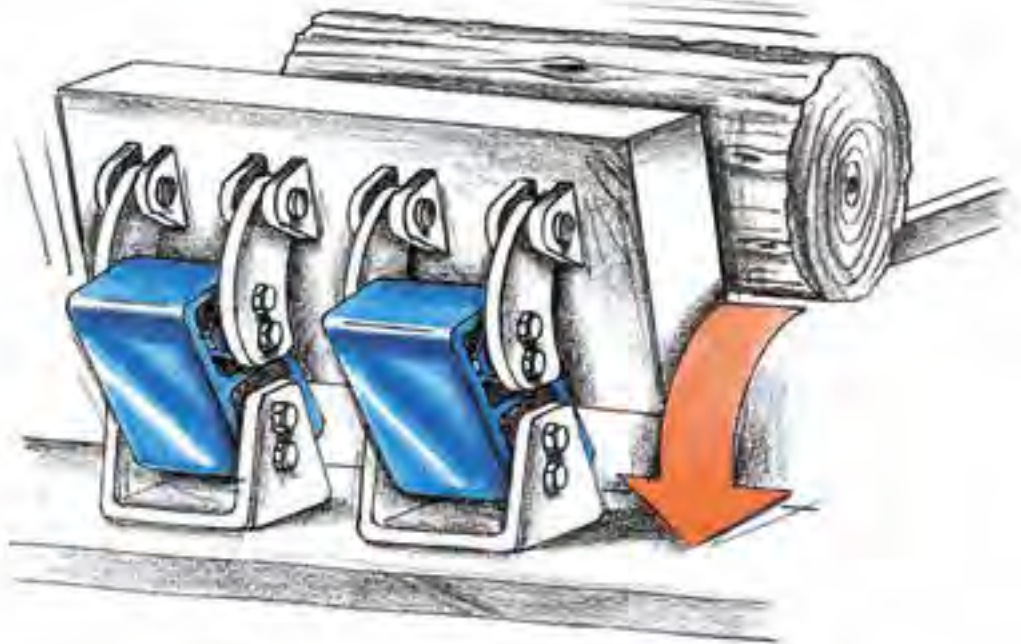



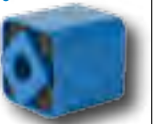



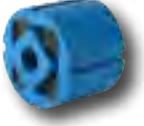

DO-A

energy absorbing impact suspensions

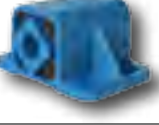

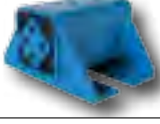
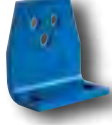
# Selection chart for rubber suspension standard elements with Rubmix 10

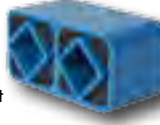
Inner square Housing	A Light metal profile, as from size 60 in steel	C Light metal profile	S Steel tube for plug-in connection	Accessories for housing Steel parts
DR Steel tube	DR-A 15 to 50  Page 1.6	DR-C 15 to 50  Page 1.6	DR-S 11 to 50  Page 1.7	Bracket BR 11 to 50  Page 1.7
DK Light metal profile	DK-A 15 to 50  Page 1.8	DK-C on request 	DK-S 11 to 50  Page 1.8	Bracket BK 11 to 50  Page 1.9
DW Light metal profile	DW-A 15 to 38  Page 1.10	DW-C 15 to 38  Page 1.10	DW-S 15 to 38  Page 1.10	Accessories for inner square A Steel parts
DW Nodular cast iron	DW-A 45 and 50  Page 1.11	DW-C 45 and 50 on request 	DW-S 45 and 50  Page 1.11	
DW Steel welded construction	DW-A 60 to 100  Page 1.11			WS 11 to 50  Page 1.13
DO Light metal profile Size 50 in nodular cast iron	DO-A 15 to 50  Page 1.12	DO-C on request 	DO-S on request 	
Housing Specification inner squares	Ideal for alternating motions over neutral element position. For sizes DR 15–45: Fixation by means of 2 to 4 persistent threaded bars (sizes DR 27–45 also available with threaded holes).		Friction locking of the core by means of one central bolt, can be positioned in full 360° angle-range. For ideal friction locking, please remove paint cover on face side. For alternating element motion of max. ±10°.	For plug-in connection with square profile*. Plug-in length min. 2 x width across flat "C". Connection is not recommendable by alternating motions – play between the plugged squares.

\* The square should be made out of bright steel, tolerance h9–h11. Possibly, the edges have to be overwinded (edge-radius in element profile max. 1.5 mm).

## Specification

### DR-A 15 x 25

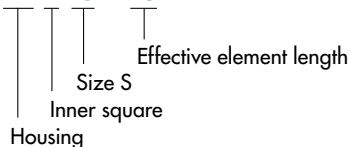

## General

- Light metal profiles: extruded profiles, seawater resistant (DIN 1725).
- Blue protection paint: water-soluble paint, coating thickness 40–80 µm.
- Fixation screws: minimum strength class of 8.8
- Welding on elements: do not weld on rubber suspensions – welding heat will affect or destroy the rubber inserts – ask for customized elements
- Most of the elements can be supplied in stainless steel version – also zinc-plated versions or special paintings are available.

Further customized elements: see examples on page 1.14 to 1.19.

# List of torque and loads

The values stated in the below mentioned list have been measured statically and are valid for the standard rubber quality "Rubmix 10". Intermediate values can be interpolated. By applications with combined dynamic forces and high angles of oscillation please consult our ROSTA general catalogue, chapter "Technology" or contact ROSTA.

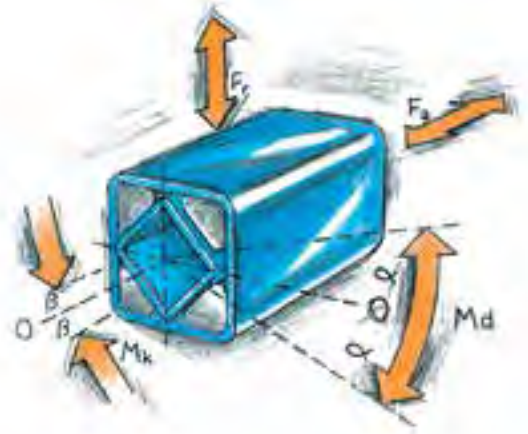

Element Nominal size x Length	Torque Md [Nm] angle $\pm\alpha^\circ$						Cardanic Mk [Nm] angle $\pm\beta^\circ$	Radial		Axial	
	5°	10°	15°	20°	25°	30°		Deflection $\pm s_r$ [mm]	Load $F_r$ [N]	Deflection $\pm s_a$ [mm]	Load $F_a$ [N]
11 x 20	0.3	0.8	1.3	2.0	2.9	4.0	0.4		200		60
	0.4	1.2	2.0	3.1	4.3	6.0	1.1	0.25	340	0.25	80
	0.7	2.0	3.4	5.1	7.2	10.0	5.6		600		150
15 x 25	0.7	1.6	2.6	4.0	5.7	8.2	0.6		200		70
	1.1	2.5	4.2	6.4	9.2	13.2	2.0	0.25	300	0.25	100
	1.6	3.8	6.3	9.6	13.8	19.8	5.5		500		160
18 x 30	1.9	4.5	7.5	11.0	15.0	20.6	1.6		400		80
	3.2	7.5	12.5	18.3	25.0	34.4	7.0	0.25	700	0.25	160
	5.1	12.0	20.0	29.3	40.0	55.0	28.0		1000		300
27 x 40	4.7	10.7	17.5	26.9	39.5	57.0	3.8		800		200
	7.0	16.0	26.3	40.3	59.3	85.5	11.5	0.5	1300	0.5	300
	11.7	26.7	43.8	67.2	98.8	142.5	48.0		2400		600
38 x 60	13.0	30.4	50.6	78.0	113.0	162.0	11.4		1500		300
	17.3	40.5	67.5	104.0	151.0	216.0	24.7	0.5	2000	0.5	500
	26.0	60.8	101.2	156.0	226.0	324.0	76.0		3000		600
45 x 80	27.6	62.4	104.0	160.0	222.0	320.0	28.0		1900		560
	34.5	78.0	130.0	200.0	278.0	400.0	54.0	0.5	3000	0.5	700
	51.8	117.0	195.0	300.0	420.0	600.0	140.0		4800		1000
50 x 120	51	133	250	395	570	780	80		2800		800
	77	197	363	570	820	1115	145	0.5	4500	0.5	950
	102	260	475	745	1070	1450	250		6300		1100
	150	385	700	1100	1590	2160	1200		8600		2200
60 x 150	75	170	300	460	700	1010	90		5400		1600
	95	220	385	610	930	1380	250	1.0	7200	1.0	2200
	140	365	630	995	1550	2240	900		9400		3200
70 x 200	140	380	650	1040	1490	2120	280		9000		2200
	190	525	910	1470	2160	3150	1200	1.0	12'000	1.0	3600
	250	765	1315	2160	3175	4750	2200		14'000		4000
80 x 200	200	500	850	1300	1900	2700	680		10'000		2500
	300	800	1300	2000	2900	4100	1500	1.0	15'000	1.0	3800
	400	1060	1800	2800	3900	5600	4600		19'000		4700
100 x 250	400	1080	1800	2800	4100	6300	1200		15'000		3200
	640	1700	2900	4500	6600	10'000	4300	1.0	28'000	1.0	5800
	800	2160	3600	5600	8200	12'000	8000		38'000		7500

# Rubber Suspension Units

## Type DR-A

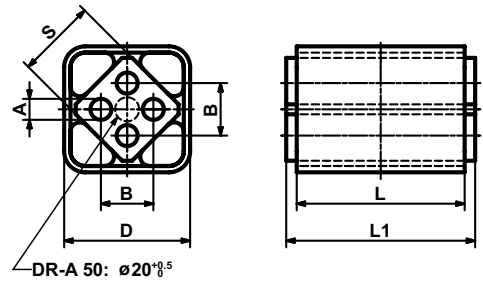

## Type DR-C

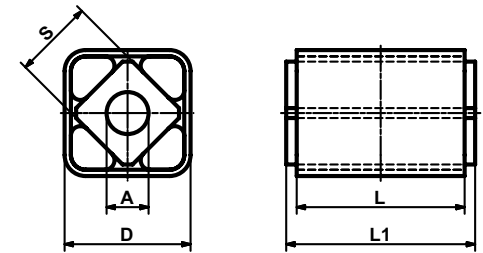

DR-A				DR-C			□D	□S	L	L1 ±0.2	Weight [kg]
Art. No.	Type	$\varnothing A^{+0.5}_0$	B	Art. No.	Type	$\varnothing A$					
01 011 001	DR-A 15x 25	5	10 ±0.2	01 031 010	DR-C 15x 25	10 $^{+0.4}_{+0.2}$	27 $^{+0.4}_0$	15	25	30	0.06
01 011 002	DR-A 15x 40			01 031 011	DR-C 15x 40				40	45	0.10
01 011 003	DR-A 15x 60			01 031 012	DR-C 15x 60				60	65	0.15
01 011 004	DR-A 18x 30	6	12 ±0.3	01 031 001	DR-C 18x 30	13 $^0_{-0.2}$	32 $^{+0.3}_{-0.1}$	18	30	35	0.10
01 011 005	DR-A 18x 50			01 031 002	DR-C 18x 50				50	55	0.16
01 011 006	DR-A 18x 80			01 031 003	DR-C 18x 80				80	85	0.25
01 011 007	DR-A 27x 40	8	20 ±0.4	01 031 004	DR-C 27x 40	16 $^{+0.5}_{+0.3}$	45 $^{+0.4}_0$	27	40	45	0.25
01 011 008	DR-A 27x 60			01 031 005	DR-C 27x 60				60	65	0.36
01 011 009	DR-A 27x100			01 031 006	DR-C 27x100				100	105	0.60
01 011 010	DR-A 38x 60	10	25 ±0.4	01 031 007	DR-C 38x 60	20 $^{+0.5}_{+0.2}$	60 $^{+0.3}_{-0.2}$	38	60	70	0.60
01 011 011	DR-A 38x 80			01 031 008	DR-C 38x 80				80	90	0.79
01 011 012	DR-A 38x120			01 031 009	DR-C 38x120				120	130	1.16
01 011 023	DR-A 45x 80	12	35 ±0.5	01 031 023	DR-C 45x 80	24 $^{+0.5}_{+0.2}$	75 $^{+0.3}_{-0.2}$	45	80	90	1.25
01 011 024	DR-A 45x100			01 031 024	DR-C 45x100				100	110	1.53
01 011 025	DR-A 45x150			01 031 024	DR-C 45x100				150	160	2.30
01 011 026	DR-A 50x120	M12x40	40 ±0.5	01 031 025	DR-C 50x120	30 $^{+0.5}_{+0.2}$	80 $^{+0.3}_{-0.2}$	50	120	130	2.07
01 011 027	DR-A 50x200			01 031 026	DR-C 50x200				200	210	3.45
01 011 028	DR-A 50x300								300	310	5.15

List of torque and loads on page 1.5.

Further information to customized elements and installation examples as from page 1.14.



# Rubber Suspension Units

## Type DR-S

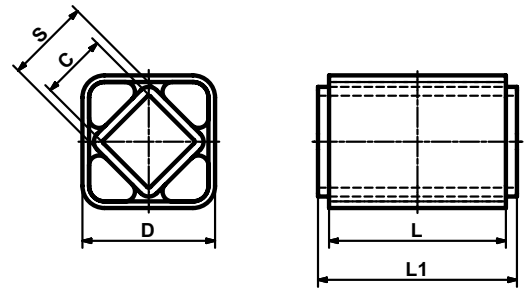

## Accessory Bracket BR

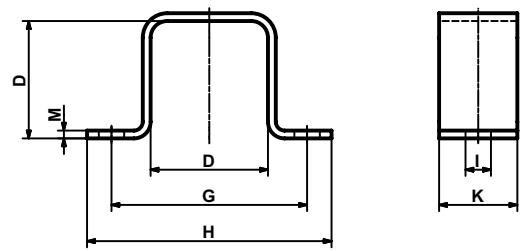

DR-S		□C	□D	□S	L	L1 ±0.2	Weight [kg]
Art. No.	Type						
01 021 001	DR-S 11x 20	8 <sup>+0.25</sup> <sub>0</sub>	20 <sup>+0.3</sup> <sub>-0.1</sub>	11	20	25	0.04
01 021 002	DR-S 11x 30				30	35	0.05
01 021 003	DR-S 11x 50				50	55	0.08
01 021 004	DR-S 15x 25	11 <sup>+0.25</sup> <sub>0</sub>	27 <sup>+0.4</sup> <sub>0</sub>	15	25	30	0.07
01 021 005	DR-S 15x 40				40	45	0.12
01 021 006	DR-S 15x 60				60	65	0.18
01 021 007	DR-S 18x 30	12 <sup>+0.25</sup> <sub>0</sub>	32 <sup>+0.3</sup> <sub>-0.1</sub>	18	30	35	0.12
01 021 008	DR-S 18x 50				50	55	0.20
01 021 009	DR-S 18x 80				80	85	0.32
01 021 010	DR-S 27x 40	22 <sup>+0.25</sup> <sub>0</sub>	45 <sup>+0.4</sup> <sub>0</sub>	27	40	45	0.26
01 021 011	DR-S 27x 60				60	65	0.39
01 021 012	DR-S 27x100				100	105	0.65
01 021 013	DR-S 38x 60	30 <sup>+0.25</sup> <sub>0</sub>	60 <sup>+0.3</sup> <sub>-0.2</sub>	38	60	70	0.67
01 021 014	DR-S 38x 80				80	90	0.90
01 021 015	DR-S 38x120				120	130	1.32
01 021 026	DR-S 45x 80	35 <sup>+0.4</sup> <sub>0</sub>	75 <sup>+0.3</sup> <sub>-0.2</sub>	45	80	90	1.42
01 021 027	DR-S 45x100				100	110	1.76
01 021 028	DR-S 45x150				150	160	2.62
01 021 029	DR-S 50x120	40 <sup>+0.4</sup> <sub>0</sub>	80 <sup>+0.3</sup> <sub>-0.2</sub>	50	120	130	2.37
01 021 030	DR-S 50x200				200	210	3.91
01 021 031	DR-S 50x300				300	310	5.80

Bracket BR		D	G	H	øI	K	M	Weight [kg]
Art. No.	Type							
01 500 001	BR 11	20	37	50	6	20	2	0.03
01 500 002	BR 15	27	50	65	7	25	2	0.04
01 500 003	BR 18	32	60	80	9	30	2.5	0.08
01 500 004	BR 27	45	80	105	11	35	3	0.15
01 500 005	BR 38	60	100	125	13	40	4	0.27
01 500 026	BR 45	75	120	150	13	45	5	0.48
01 500 027	BR 50	80	135	175	18	50	6	0.71

List of torque and loads on page 1.5.

Further information to customized elements and installation examples as from page 1.14.



# Rubber Suspension Units

## Type DK-A

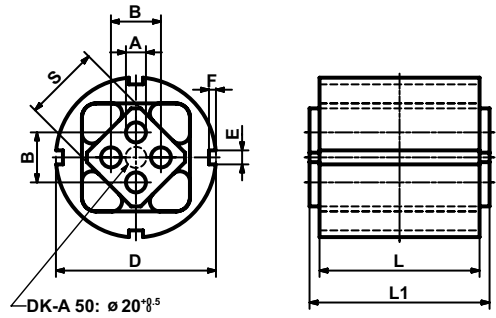

## Type DK-S

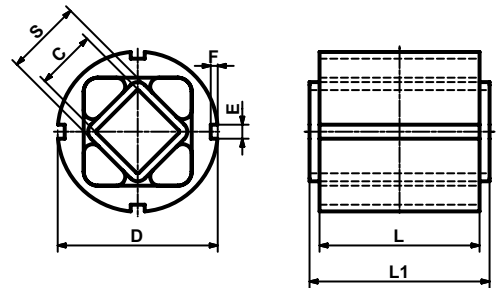

DK-A				DK-S				øD	E	F	□S	L	L1 ±0.2		
Art. No.	Type	øA <sup>+0.5</sup> / <sub>0</sub>	B	Weight [kg]	Art. No.	Type	□C							Weight [kg]	
					01 081 001	<b>DK-S 11x 20</b>	8 <sup>+0.25</sup> / <sub>0</sub>	0.03	28 <sup>+0.5</sup> / <sub>+0.1</sub>	4	2.5	11	20	25	
					01 081 002	<b>DK-S 11x 30</b>							0.05	30	35
					01 081 003	<b>DK-S 11x 50</b>							0.07	50	55
01 071 001	<b>DK-A 15x 25</b>	5	10 ±0.2	0.05	01 081 004	<b>DK-S 15x 25</b>	11 <sup>+0.25</sup> / <sub>0</sub>	0.06	36 <sup>+0.5</sup> / <sub>+0.1</sub>	5	2.5	15	25	30	
01 071 002	<b>DK-A 15x 40</b>			0.08	01 081 005	<b>DK-S 15x 40</b>							0.10	40	45
01 071 003	<b>DK-A 15x 60</b>			0.12	01 081 006	<b>DK-S 15x 60</b>							0.14	60	65
01 071 004	<b>DK-A 18x 30</b>	6	12 ±0.3	0.10	01 081 007	<b>DK-S 18x 30</b>	12 <sup>+0.25</sup> / <sub>0</sub>	0.13	45 <sup>+0.6</sup> / <sub>+0.1</sub>	5	2.5	18	30	35	
01 071 005	<b>DK-A 18x 50</b>			0.16	01 081 008	<b>DK-S 18x 50</b>							0.20	50	55
01 071 006	<b>DK-A 18x 80</b>			0.26	01 081 009	<b>DK-S 18x 80</b>							0.33	80	85
01 071 007	<b>DK-A 27x 40</b>	8	20 ±0.4	0.25	01 081 010	<b>DK-S 27x 40</b>	22 <sup>+0.25</sup> / <sub>0</sub>	0.27	62 <sup>+0.7</sup> / <sub>+0.1</sub>	6	3	27	40	45	
01 071 008	<b>DK-A 27x 60</b>			0.37	01 081 011	<b>DK-S 27x 60</b>							0.40	60	65
01 071 009	<b>DK-A 27x100</b>			0.62	01 081 012	<b>DK-S 27x100</b>							0.66	100	105
01 071 010	<b>DK-A 38x 60</b>	10	25 ±0.4	0.63	01 081 013	<b>DK-S 38x 60</b>	30 <sup>+0.25</sup> / <sub>0</sub>	0.72	80 <sup>+0.8</sup> / <sub>+0.1</sub>	7	3.5	38	60	70	
01 071 011	<b>DK-A 38x 80</b>			0.83	01 081 014	<b>DK-S 38x 80</b>							0.94	80	90
01 071 012	<b>DK-A 38x120</b>			1.22	01 081 015	<b>DK-S 38x120</b>							1.37	120	130
01 071 013	<b>DK-A 45x 80</b>	12	35 ±0.5	1.15	01 081 016	<b>DK-S 45x 80</b>	35 <sup>+0.4</sup> / <sub>0</sub>	1.35	95 <sup>+1.0</sup> / <sub>+0.1</sub>	8	4	45	80	90	
01 071 014	<b>DK-A 45x100</b>			1.44	01 081 017	<b>DK-S 45x100</b>							1.65	100	110
01 071 015	<b>DK-A 45x150</b>			2.12	01 081 018	<b>DK-S 45x150</b>							2.44	150	160
01 071 016	<b>DK-A 50x120</b>	M12x40	40 ±0.5	2.35	01 081 019	<b>DK-S 50x120</b>	40 <sup>+0.4</sup> / <sub>0</sub>	2.55	108 <sup>+1.2</sup> / <sub>+0.1</sub>	8	4	50	120	130	
01 071 017	<b>DK-A 50x200</b>			3.75	01 081 020	<b>DK-S 50x200</b>							4.21	200	210
01 071 018	<b>DK-A 50x300</b>			5.60	01 081 021	<b>DK-S 50x300</b>							6.45	300	310

List of torque and loads on page 1.5.

Further information to customized elements and installation examples as from page 1.14.





# Rubber Suspension Units

## Accessory Bracket BK

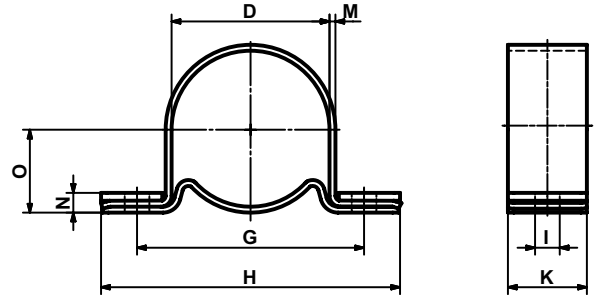

Bracket BK										Weight
Art. No.	Type	D	G	H	øI	K	M	N	O	[kg]
01 520 001	<b>BK 11</b>	28	45	60	6.5	20	1.5	6	15.5	0.04
01 520 002	<b>BK 15</b>	36	55	75	6.5	25	2	7	20.0	0.09
01 520 003	<b>BK 18</b>	45	68	90	8.5	30	2	8	24.5	0.14
01 520 004	<b>BK 27</b>	62	92	125	10.5	35	2.5	10	33.5	0.29
01 520 005	<b>BK 38</b>	80	115	150	12.5	40	3	11	43.0	0.45
01 520 006	<b>BK 45</b>	95	130	165	12.5	45	4	14	51.5	0.74
01 520 007	<b>BK 50</b>	108	152	195	16.5	50	4	15	58.0	0.93

With the use of the BK bracket the working position of the DK element can be selected in the full angle-range of 360°.



List of torque and loads on page 1.5.

Further information to customized elements and installation examples as from page 1.14.

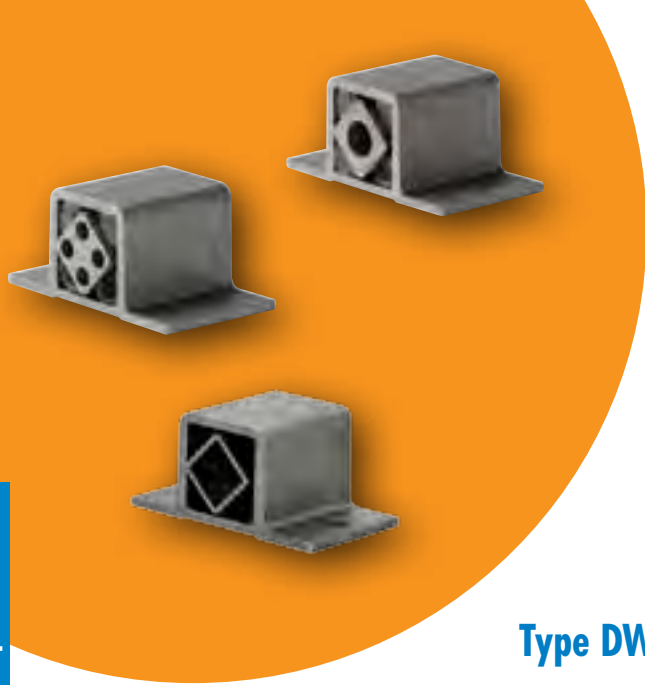

# Rubber Suspension Units

## Type DW-A 15 to 38

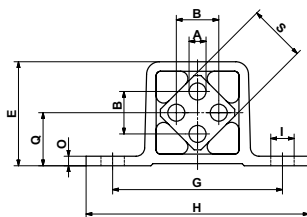

## Type DW-C 15 to 38

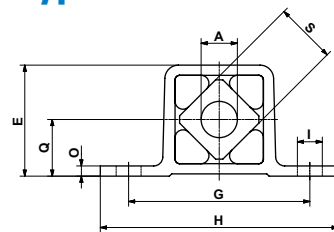

## Type DW-S 15 to 38

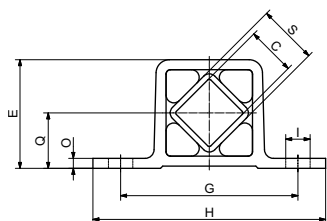

## Length dimensions all types

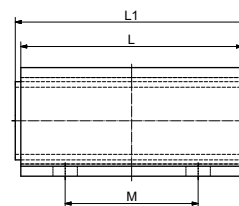
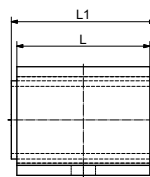

DW-A 15 to 38				DW-C 15 to 38											Weight [kg]		
Art. No.	Type	$\varnothing A^{+0.5}$	B	Art. No.	Type	$\varnothing A$	E	G	H	$\varnothing I$	O	Q	$\square S$	L		$L1_{-0.3}$	M
01 101 016	DW-A 15x 25	5	10 $\pm 0.2$	01 121 101	DW-C 15x 25	10 $^{+0.4}_{-0.2}$	29	50	65	7	3	15	15	25	30	-	0.05
01 101 017	DW-A 15x 40			01 121 102	DW-C 15x 40									40	45	-	0.07
01 101 018	DW-A 15x 60			01 121 103	DW-C 15x 60									60	65	40	0.11
01 101 019	DW-A 18x 30	6	12 $\pm 0.3$	01 121 104	DW-C 18x 30	13 $^{0}_{-0.2}$	35	60	80	9	3.5	18	18	30	35	-	0.08
01 101 020	DW-A 18x 50			01 121 105	DW-C 18x 50									50	55	-	0.13
01 101 021	DW-A 18x 80			01 121 106	DW-C 18x 80									80	85	50	0.21
01 101 022	DW-A 27x 40	8	20 $\pm 0.4$	01 121 107	DW-C 27x 40	16 $^{+0.5}_{-0.3}$	49	80	105	11	4.5	25	27	40	45	-	0.21
01 101 023	DW-A 27x 60			01 121 108	DW-C 27x 60									60	65	-	0.31
01 101 024	DW-A 27x100			01 121 109	DW-C 27x100									100	105	60	0.52
01 101 025	DW-A 38x 60	10	25 $\pm 0.4$	01 121 110	DW-C 38x 60	20 $^{+0.5}_{-0.2}$	67	100	125	13	6	34	38	60	70	-	0.59
01 101 026	DW-A 38x 80			01 121 111	DW-C 38x 80									80	90	40	0.77
01 101 027	DW-A 38x120			01 121 112	DW-C 38x120									120	130	80	1.15

DW-S 15 to 38												Weight [kg]	
Art. No.	Type	$\square C$	E	G	H	$\varnothing I$	O	Q	$\square S$	L	$L1_{\pm 0.2}$		M
01 111 201	DW-S 15x 25	11 $^{+0.25}_{0}$	29	50	65	7	3	15	15	25	30	-	0.06
01 111 202	DW-S 15x 40									40	45	-	0.09
01 111 203	DW-S 15x 60									60	65	40	0.13
01 111 204	DW-S 18x 30	12 $^{+0.25}_{0}$	35	60	80	9	3.5	18	18	30	35	-	0.11
01 111 205	DW-S 18x 50									50	55	-	0.18
01 111 206	DW-S 18x 80									80	85	50	0.28
01 111 207	DW-S 27x 40	22 $^{+0.25}_{0}$	49	80	105	11	4.5	25	27	40	45	-	0.23
01 111 208	DW-S 27x 60									60	65	-	0.33
01 111 209	DW-S 27x100									100	105	60	0.56
01 111 210	DW-S 38x 60	30 $^{+0.25}_{0}$	67	100	125	13	6	34	38	60	70	-	0.66
01 111 211	DW-S 38x 80									80	90	40	0.87
01 111 212	DW-S 38x120									120	130	80	1.30

**DW-S 15 to 38**  
Inner part steel electrodeposited galvanic zinc coating

List of torque and loads on page 1.5.

Further information to customized elements and installation examples as from page 1.14.

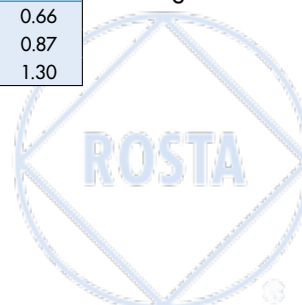

# Rubber Suspension Units

## Type DW-A 45 and 50

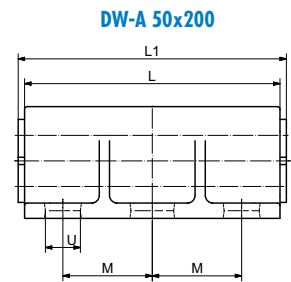
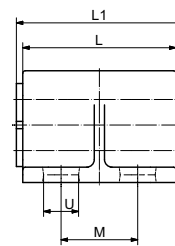
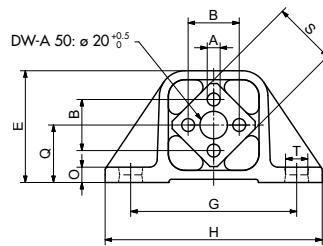

## Type DW-S 45 and 50

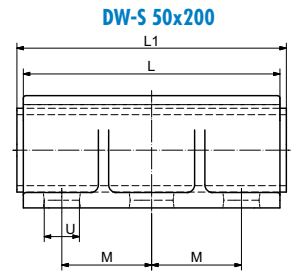
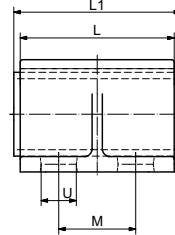
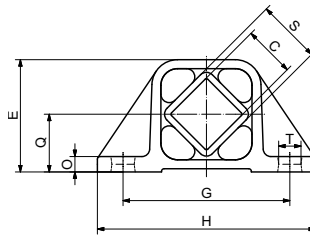

Rubber Suspension Units

DW-A 45 and 50				DW-S 45 and 50															
Art. No.	Type	A	B	Weight [kg]	Art. No.	Type	□C	Weight [kg]	E	G	H	O	Q	□S	T	U	L	L1±0.2	M
01 101 015	DW-A 45x100	∅ 12 <sup>+0.5</sup>	35	2.3	01 111 015	DW-S 45x100	35 <sup>+0.4</sup>	2.6	80	115	145	8	41	45	13	26	100	110	58
01 101 013	DW-A 50x120	M12x40	40	3.7	01 111 013	DW-S 50x120	40 <sup>+0.4</sup>	4.0	88	130	170	12	45	50	17	27	120	130	60
01 101 028	DW-A 50x160			5.0	01 111 028	DW-S 50x160		5.3									160	170	70
01 101 014	DW-A 50x200			6.1	01 111 014	DW-S 50x200		6.6									200	210	70

## Type DW-A 60 to 100

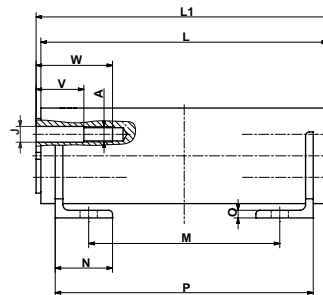
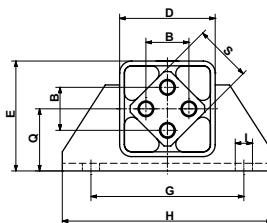

DW-A 60 to 100																	Weight [kg]			
Art. No.	Type	A	B	D	E	G	H	∅I	∅J	N	O	Q	□S	V	W	L	L1±0.2	M	P	Weight [kg]
01 101 031	DW-A 60x150	M16	45	100	115	160	220	18	16.5	60	8	65	60	40	70	150	160	60	130	8.9
01 101 032	DW-A 60x200															200	210	100	170	11.1
01 101 033	DW-A 60x300															300	310	200	270	15.9
01 101 034	DW-A 70x200	M20	50	120	140	200	260	22	20.5	65	9	80	70	50	90	200	210	100	170	15.4
01 101 035	DW-A 70x300															300	310	200	270	21.7
01 101 036	DW-A 70x400															400	410	300	370	28.2
01 101 037	DW-A 80x200	M20	60	136	153	220	280	22	20.5	80	10	85	80	50	90	200	210	80	170	21.7
01 101 038	DW-A 80x300															300	310	180	270	30.4
01 101 039	DW-A 80x400															400	410	280	370	39.4
01 101 040	DW-A 100x250	M24	75	170	195	300	380	26	25	100	12	110	100	50	100	250	260	110	220	43.8
01 101 041	DW-A 100x400															400	410	260	370	64.7
01 101 042	DW-A 100x500															500	510	360	470	78.7

List of torque and loads on page 1.5.

Further information to customized elements and installation examples as from page 1.14.



# Rubber Suspension Units

## Type DO-A 15 to 45

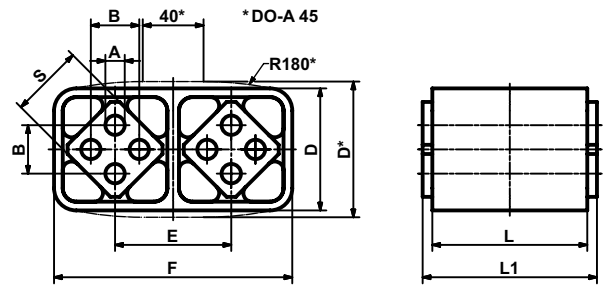

## Type DO-A 50

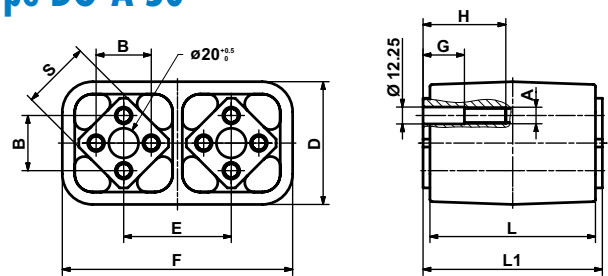

DO-A												Weight
Art. No.	Type	$\varnothing A^{+0.5}_0$	B	D	E	F	$\square S$	G	H	L	$L1 \pm 0.2$	[kg]
01 041 001	DO-A 15x 25									25	30	0.07
01 041 002	DO-A 15x 40	5	$10 \pm 0.2$	$28 \pm 0.15$	25.5	$53.5 \pm 0.2$	15	-	-	40	45	0.10
01 041 003	DO-A 15x 60									60	65	0.15
01 041 004	DO-A 18x 30									30	35	0.12
01 041 005	DO-A 18x 50	6	$12 \pm 0.3$	$34 \pm 0.15$	31	$65 \pm 0.2$	18	-	-	50	55	0.20
01 041 006	DO-A 18x 80									80	85	0.30
01 041 007	DO-A 27x 40									40	45	0.32
01 041 008	DO-A 27x 60	8	$20 \pm 0.4$	$47 \pm 0.15$	44	$91 \pm 0.2$	27	-	-	60	65	0.47
01 041 009	DO-A 27x100									100	105	0.78
01 041 010	DO-A 38x 60									60	70	0.87
01 041 011	DO-A 38x 80	10	$25 \pm 0.4$	$63 \pm 0.2$	60	$123 \pm 0.3$	38	-	-	80	90	1.15
01 041 012	DO-A 38x120									120	130	1.68
01 041 013	DO-A 45x 80									80	90	1.85
01 041 014	DO-A 45x100	12	$35 \pm 0.5$	$85 \pm 0.5$	73	$150 \pm 1$	45	-	-	100	110	2.25
01 041 015	DO-A 45x150									150	160	3.35
01 041 016	DO-A 50x120							30	60	120	130	5.50
01 041 019	DO-A 50x160	M12	$40 \pm 0.5$	ca. 89	78	ca. 168	50	30	60	160	170	7.40
01 041 017	DO-A 50x200							40	70	200	210	8.50

List of torque and loads on page 1.5.

Further information to customized elements and installation examples as from page 1.14.



# Rubber Suspension Units

## Serial Connection

**Doubled oscillating angle**  
( $\pm 60^\circ$ ) at constant torque of a single unit.

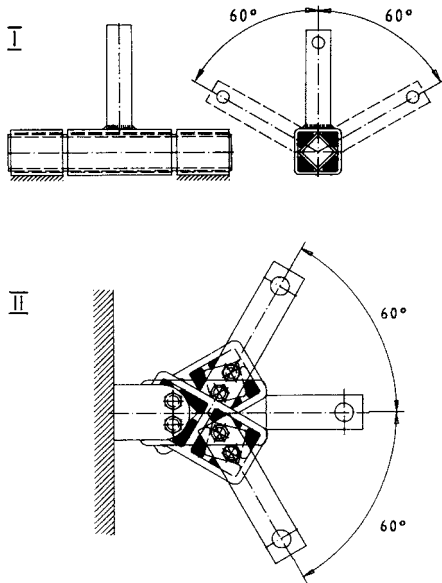

## Parallel Connection

**Doubled torque momentum**  
at constant oscillating angle ( $\pm 30^\circ$ ).

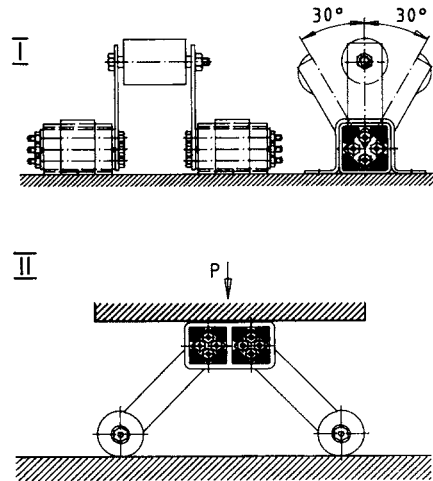

## Accessory Bracket WS

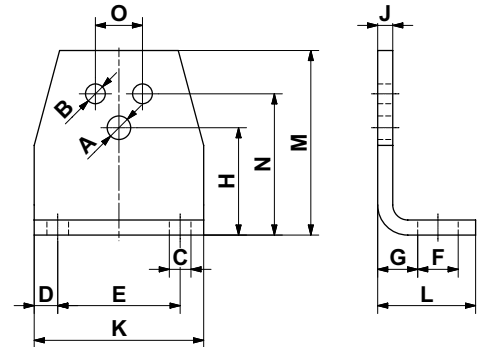

Bracket WS		Fit for tensioner devices			Fit for DR-A, DK-A, DW-A												Weight [kg]	
Art. No.	Type	SE size	$\phi A$	H	Element size	$\phi B$	N	O	C	D	E	F	G	J	K	L		M
06 590 001	WS 11-15	11	6.5	27	15	5.5	35	10	7	7.5	30	13	11.5	4	45	30	46	0.08
06 590 002	WS 15-18	15	8.5	34	18	6.5	44	12	7	7.5	40	13	13.5	5	55	32	58	0.15
06 590 003	WS 18-27	18	10.5	43	27	8.5	55	20	9.5	10	50	15.5	16.5	6	70	38	74	0.28
06 590 004	WS 27-38	27	12.5	57	38	10.5	75	25	11.5	12.5	65	21.5	21	8	90	52	98	0.70
06 590 005	WS 38-45	38	16.5	66	45	12.5	85	35	14	15	80	24	21	8	110	55	116	0.90
06 590 006	WS 45-50	45	20.5	80	50	12.5	110	40	18	20	100	30	26	10	140	66	140	1.80

# ROSTA Rubber Suspension Units

Short delivery time for the following special elements:



- Delivery summary for ROSTA rubber qualities

Rubber quality	Factor in relation to the list "torque and loads" (page 1.5)	Working temperature	Rubber	Specification
<b>Rubmix 10</b>	<b>1.0</b>	-40 ° to +80 °C	NR	- Standard quality - Highest elasticity - Lowest cold flow
<b>Rubmix 15</b>	<b>approx. 1.4</b>	-40 ° to +85 °C	SBR	- High torque values - Elements marked with black dot
<b>Rubmix 20</b>	<b>approx. 1.0</b>	-30 ° to +90 °C	CR	- Good oil-resistance - Elements marked with yellow dot
<b>Rubmix 40</b>	<b>approx. 0.6</b>	from +80 ° to +120 °C	EPDM-Silicone	- High temperature resistance - Elements marked with red dot
<b>Rubmix 50</b>	<b>approx. 3.0</b>	-35 ° to +90 °C	PUR	- Max. oscillation angle $\pm 20^\circ$ - Limited oscillation frequencies - No permanent water contact - Elements marked with green dot

- Elements with different length of housings and/or inner squares.
- DW light metal profiles with customized bores in the flange plates (quantity and position).
- Element with threaded bores in inner square: selectable for A or C inner squares, or full steel profile with required bores.
- Elements **DK-C**, **DO-C**, **DW-C** and **DO-S** (see page 1.4):

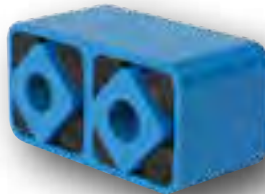
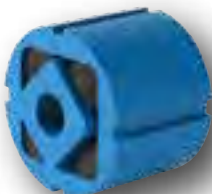
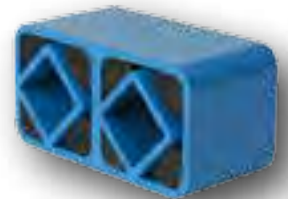

Not all sizes are available in all combinations.  
Please contact ROSTA.



# ROSTA, your system supplier since more than 70 years



Zinc-plated double element structure  
*brush suspension in car wash site*



Customized laser parts on housing  
*front wheel suspension for wheelchair*



Customized nodular cast housing  
*swivel-mount for ripper comb in shredder*



60° series connection (cast housings)  
*hinge bearing for truck engine hood*



Cataphoretic housing protection, "Rubmix 40" inserts  
*marker light suspension for truck trailers*



60° series connection (light metal profiles)  
*hinge bearing for glass shelf-cover*

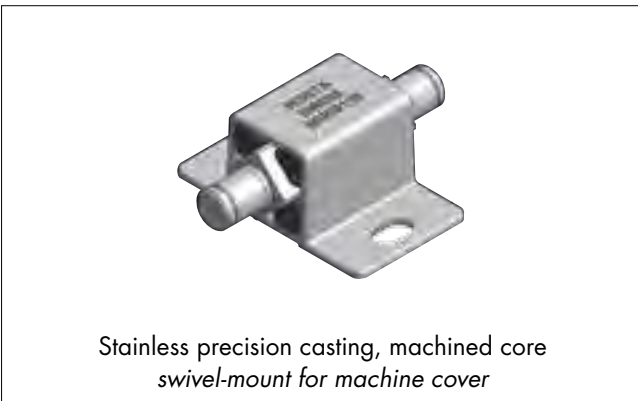

Stainless precision casting, machined core  
*swivel-mount for machine cover*



Welded structure, "Rubmix 50" inserts  
*hinge for wheelchair-ramp on busses*

Today, about 50% of all supplied rubber suspension elements are fully customized parts. With pleasure we do await your project definition for the development of an ingenious and cost-saving rubber suspension, fitting your specific requirements.

# ROSTA Rubber Suspension Units

## Examples of fixations to Housing



Fig. 1 Square tubular housing with bracket BR



Fig. 2 Round housing with bracket BK



Fig. 3 Outer housing in clamping jaw



Fig. 4 Double bracket welded on housing



Fig. 5 Plug-in connection



Fig. 6 Dual-threaded plate welded on housing



Fig. 7 Dual-levers welded on housing



Fig. 8 Bridge-clamp over housing



Fig. 9 Flange welded on housing

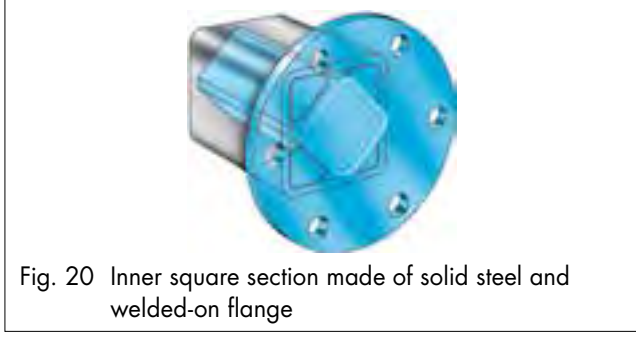
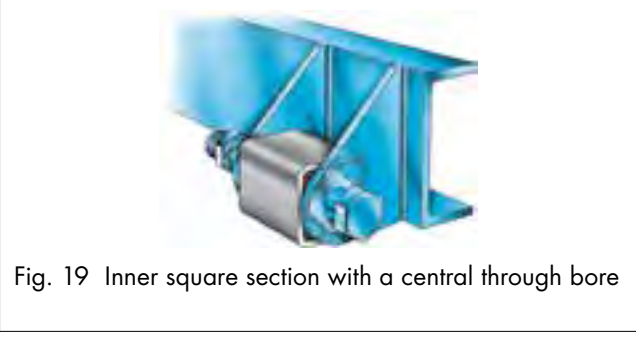
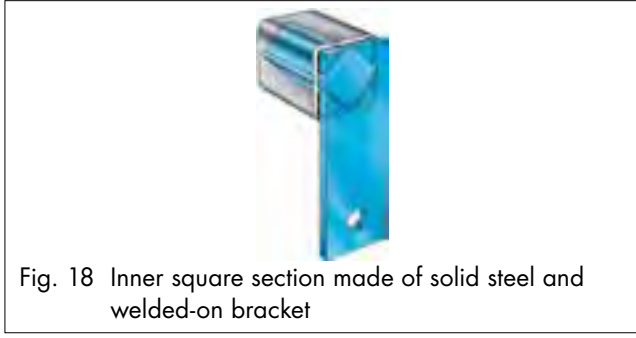
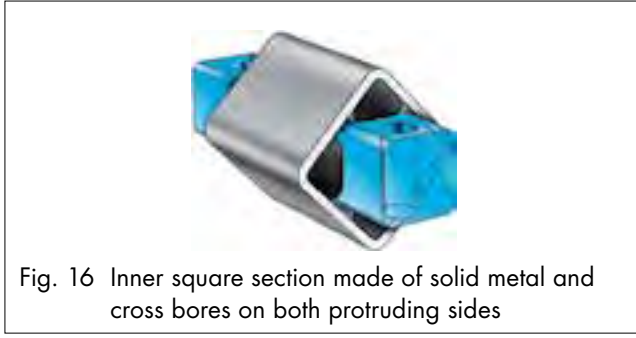
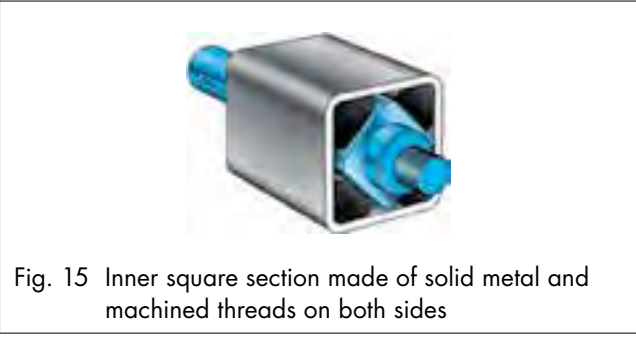
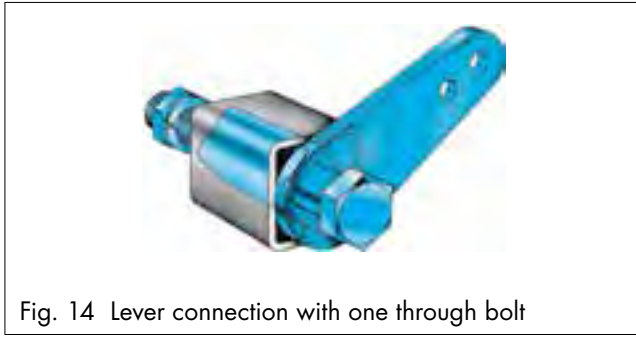
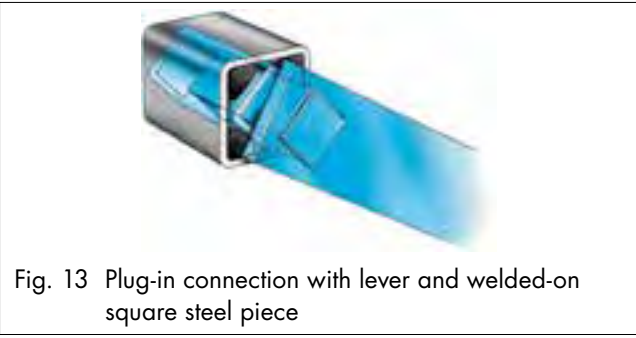
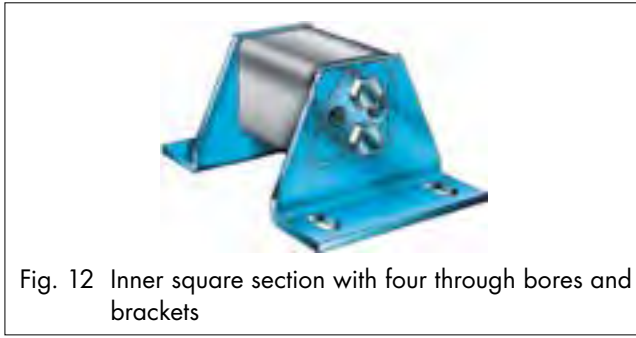
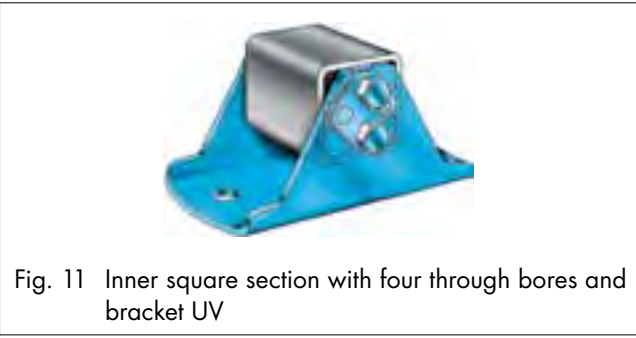

Fig. 10 Housing in cast iron



# ROSTA Rubber Suspension Units

## Examples of fixations to Inner Square Section



# ROSTA Rubber Suspension Units

## Installation Examples

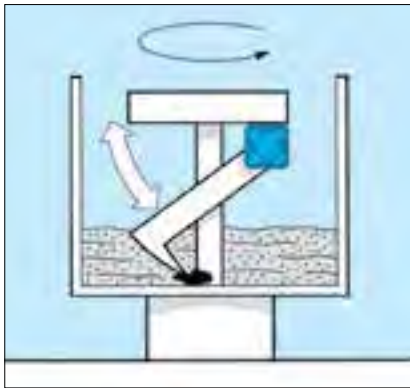

Lever bearing in concrete mixer

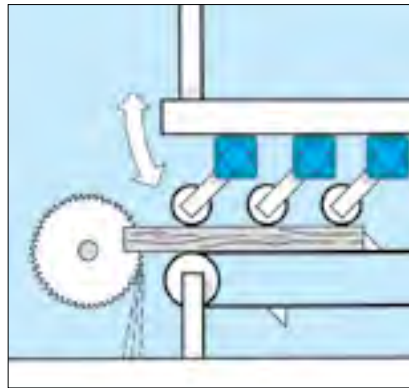

Pressure rollers in saw device

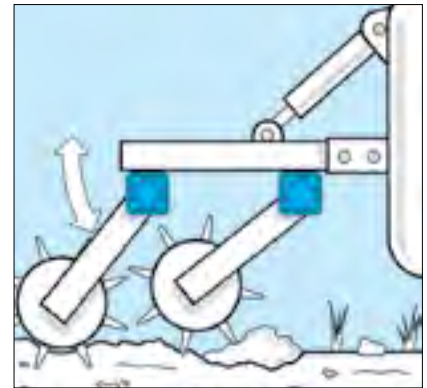

Pendulum on harrow rollers

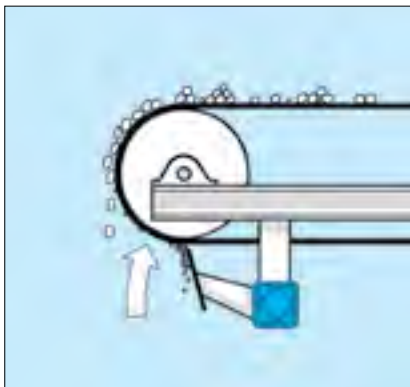

Conveyor-belt scraper

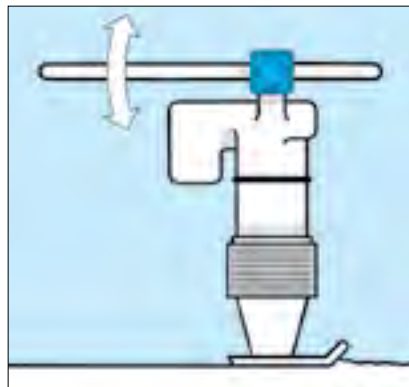

Handle-bar insulation



See-saw support

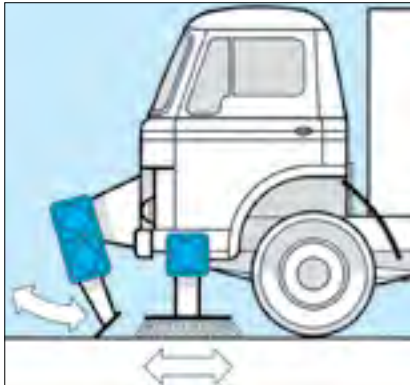

Elastical brush and scraper suspension

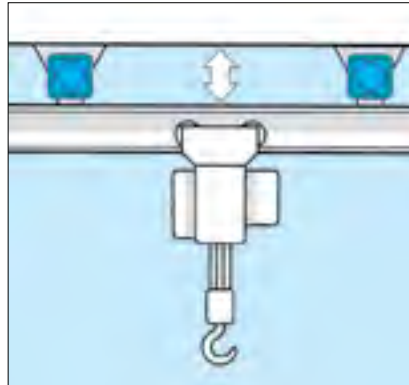

Suspended crane rail

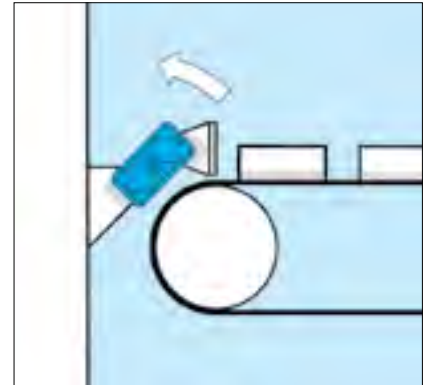

Shock absorber

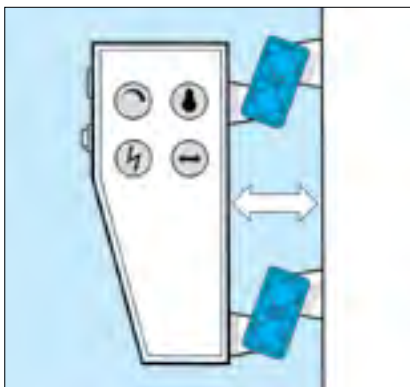

Control unit insulation

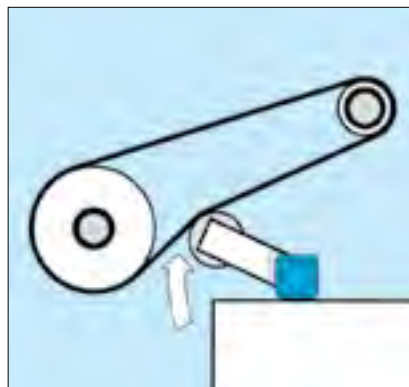

Chain and belt tensioner

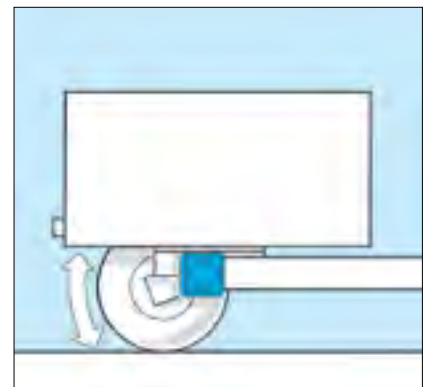

Independent wheel suspension

# ROSTA Rubber Suspension Units

## Installation Examples

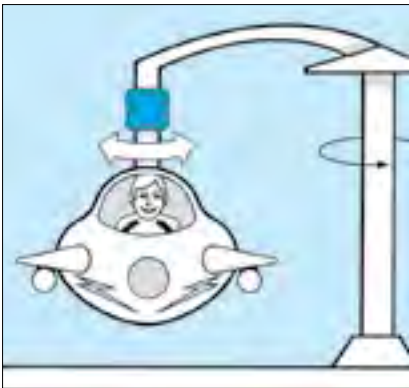

Pendulum on amusement ride

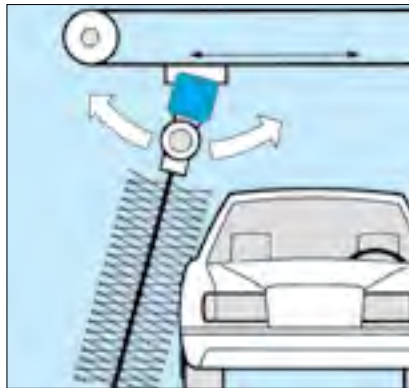

Compensation bearing for car brush

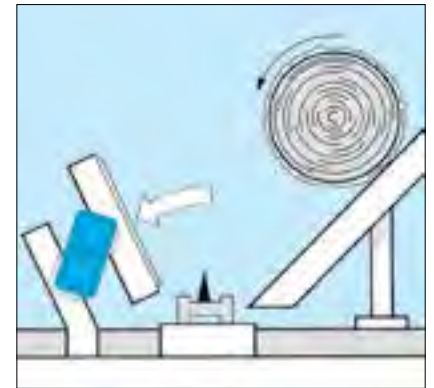

Impact suspension in feeder

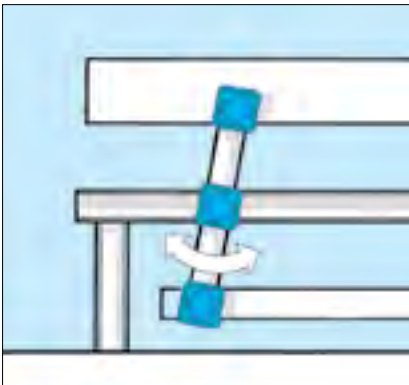

Double suspension

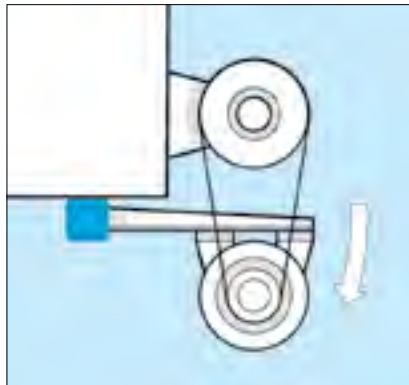

Motorbase

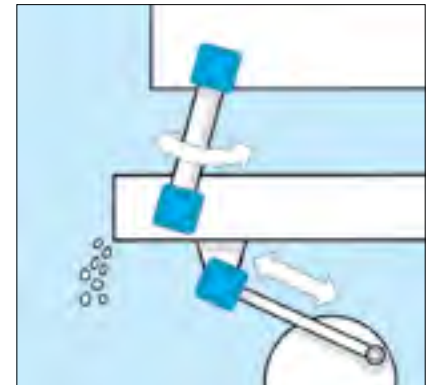

Shaker conveyor



Compactor-suspension

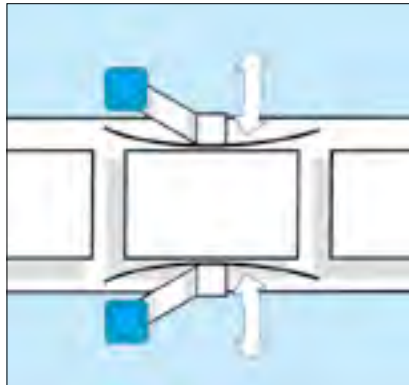

Guide rail



Suspended pawl

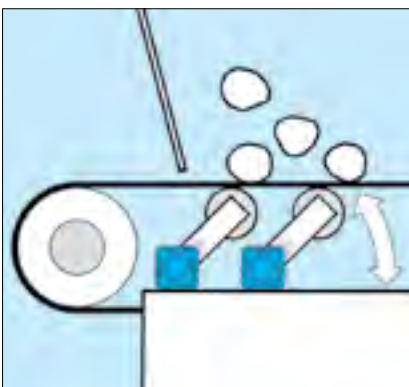

Impact-idler suspension

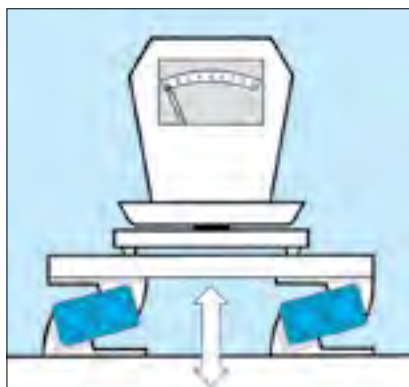

Passive insulation

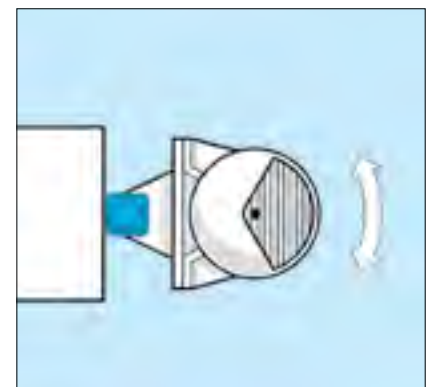

Suspended unbalanced motor

# Applications!

Examples:

Rubber Suspension Units



**ROSTA** 

ROSTA AG  
CH-5502 Hunzenschwil  
Phone +41 62 889 04 00  
Fax +41 62 889 04 99  
E-Mail [info@rosta.ch](mailto:info@rosta.ch)  
Internet [www.rosta.com](http://www.rosta.com)

Changes regarding data reserved.  
Any reprint, also in extracts, requires our explicit and confirmed approval.